

## Conference Paper

# Concurrent Design Strategy for Improving Public Wheelchairs for People with Disabilities

Shih-Wen Hsiao and Yuan-Yi Lee

Department of Industrial Design, National Cheng Kung University, Tainan, Taiwan

## Abstract

Traveling abroad is an easy activity for regular individuals, but it can be an inconvenience to those with disabilities. To ensure airport and aviation security, passengers with disabilities are required to fold and check-in their wheelchairs, use an airport-supplied wheelchair, present themselves at the airline counter, and go through a security check. Once they enter the cabin, they move to another wheelchair, which is designed to fit in the cabin aisles. Such an accessibility service of requiring passengers with disabilities to move from the airline counter in one wheelchair and then change to another in order to reach the cabin is inconvenient and underlines. Therefore, it is necessary to develop a new type of wheelchair. Based on the aforementioned reasons, this study will use a concurrent design strategy to design a wheelchair as described earlier according to the concept of simultaneous design. First, find out the positioning of the product, then use the target tree to formulate the design specification, and use the finite structure analysis method (FSM) to conceive and diverge. Then select the best solution based on PUGH concept matrix selection, and complete the detailed design and 3D model. The results show that this procedure can simplify wheelchair design, improve the competitiveness of wheelchairs in the market, meet the needs of people with disabilities, ensure wheelchair quality, and enhance the likelihood of its mass production.

**Keywords:** disabilities, concurrent design, objective tree analysis, pugh decision-matrix method

Corresponding Author:

Shih-Wen Hsiao

swhsiao@mail.ncku.edu.tw

Received: 29 August 2018

Accepted: 18 September 2018

Published: 11 November 2018

Publishing services provided by  
Knowledge E

© Shih-Wen Hsiao and Yuan-Yi Lee. This article is distributed under the terms of the [Creative Commons Attribution License](#), which permits unrestricted use and redistribution provided that the original author and source are credited.

Selection and Peer-review under the responsibility of the ICOI-2018 Conference Committee.

## 1. Introduction

The World Health Organization refers to “disability” as an impairment that may be “physical” or “mental” and defines disabilities as “an umbrella term covering impairments, activity limitations, and participation restrictions” [1]. The United Nations estimates that people with disabilities accounts for over 10% (650 million) of the world’s population. This figure is expected to rise to 19%, or even 21%, by 2030 [2]. In Taiwan, there were 1,167,450 people with disabilities as of the end of 2017 (up by 11,800 from 2015) according to the Department of Statistics of the Ministry of the Interior. Of these

### OPEN ACCESS

individuals, 31.8% (366,781) have physical disabilities. Against this background, it is necessary to design and improve disability aids.

To create accessible environments for citizens with disabilities, the U.S. government passed the Air Carrier Access Act in 1986 and the UK government passed the Disability Discrimination Act in 1995. In Taiwan, the “Welfare Law for the Handicapped and Disabled” was instituted in 1980 to ensure the accessibility of public buildings and facilities. For people with disabilities, wheelchairs are their most direct means of mobility. Therefore, designing appropriate wheelchairs for them can promote social harmony. With the rising popularity of travel, tourism-related studies have focused on tourists with disabilities [3, 4]. The number of Taiwanese traveling abroad increased by 16.2% from 8,963,712 in 2007 to 14,588,923 in 2016. The National Association Air-line recommends that the width of a cabin aisle be determined on the basis of the airplane type and the number of seats on the plane (see Table 1). The average width of cabin aisles on passenger planes is 20 inches (50.8 cm), whereas the average width of wheelchairs is 22 inches. This difference makes it necessary for passengers with disabilities to use different wheelchairs when they embark and disembark, which may inconvenience them and cause injuries.

The black-box approach is often used in the brainstorming and selection of product forms [5], although this conventional approach to wheelchair design often fails to meet consumer needs, leading resource wastage. This study examined viable solutions through rational thinking to address the limitation. Specifically, the finite structure method (FSM) was used to design the form of a wheelchair [6]. The Pugh decision-matrix method was subsequently adopted to objectively select wheelchair design concepts [7], thereby yielding optimal design solutions. This systematic design method has extensive application and reduces design costs [8, 9].

TABLE 1: Plane aisle width vs. passenger seating.

Passenger seating capacity	Minimum passenger aisle width (inches)	
	Less than 25 in. from floor	25 in. and more from floor
10 or less	12	15
11 through 19	12	20
20 or more	15	20

## 2. Methods

## 2.1. Finite structure method

The FSM uses the secondary functions of a product, which enables its intended function to determine product form, producing a finite number of structural changes to identify possible forms for the product. The method involves five steps:

1. Ascertaining the primary functions of the product to be designed.
2. Dividing the primary functions into several combinations of secondary functions and limiting the number of these combinations.
3. Structurally decomposing the combinations of secondary functions while using three variables.
4. Ensuring a diversity of forms and determining whether they meet the principles behind the product design.
5. Choosing an optimal solution.

## 2.2. Objective tree analysis

An objective tree analysis is a hierarchical structure-technique that presents an overview of a given problem and a corresponding solution and objective to it. Thus, once a problem is identified, possible solutions appear at the second level of an objective tree. The third level can be constructed from the second to present concrete solutions. In addition to showing the details about a design process, the tree may include design limitations and criteria. In this study, an objective tree analysis was performed on the intricacies of wheelchair design and the functions of wheelchairs.

## 2.3. Pugh decision-matrix method

A design process involves multiple solutions. Therefore, after a conceptual design is developed, an optimal solution should be selected among different design concepts. This can be achieved through the Pugh decision-matrix method, which has been used for determining certain design and non-design-related solutions, and has been empirically proven as simple and effective. The method involves assigning a score to each design idea according to the degree to which it meets consumer needs and comparing the scores of all design ideas to choose the best one.

### 3. Case Study

This study analyzed wheelchairs provided at Taiwan Taoyuan International Airport and Kao-hsiung International Airport in Taiwan. The analysis suggested that both airports did not provide any wheelchairs that are applicable in terminals and plane cabins alike, which can be an inconvenience to passengers with disabilities.

Commercially available wheelchairs can be broadly divided into four categories: nursing, transport, active, and electric wheelchairs. A nursing wheelchair is designed for users with moderate or severe disabilities who are unable to move unassisted. Thus, such a wheelchair is custom-made and relatively expensive. A transport wheelchair is more affordable than other types of wheelchairs. An active wheelchair is light and robust because its body is framed in aluminum, which makes the chair easy to maneuver. An electric wheelchair, although bulky, can be used on different ground surfaces, allowing users to reach their destination without having to expend much physical effort. Airports typically provide transport wheelchairs.

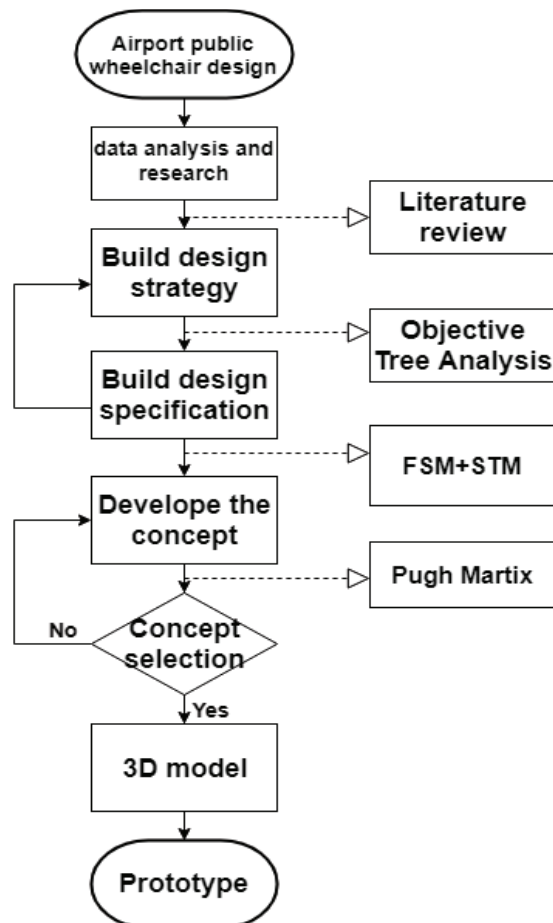
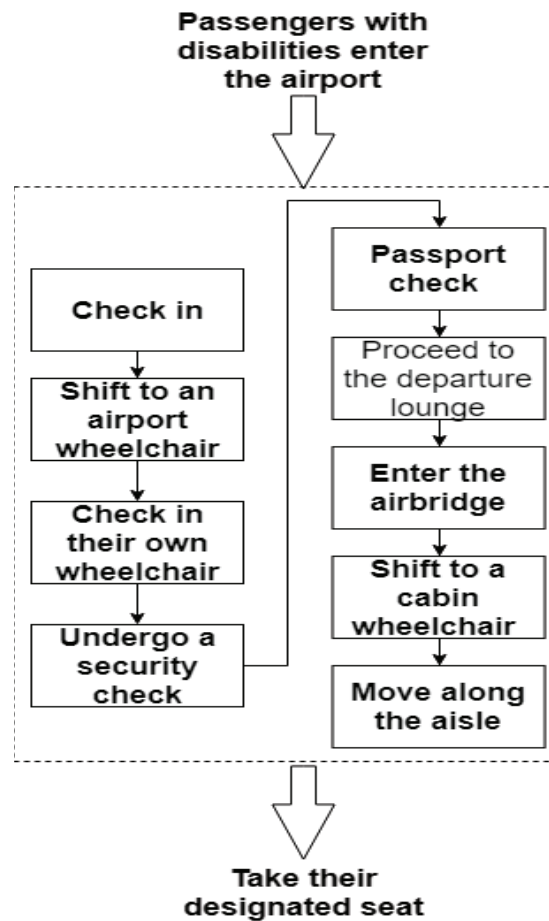

Figure 1: Design process.



**Figure 2:** Black-box decomposition procedure.

This study used the FSM to analyze the functions and forms of wheelchairs, thereby conceptualizing the proposed airport wheelchair. The wheelchair was then designed through a systematic process (Fig.1)

### 3.1. Black-box diagram

To elucidate the problems that a passenger with disabilities normally encounters when being transported from a terminal to a cabin seat, this study used a black-box decomposition approach to analyze the transporting process (Fig.2) and presented an illustration of the typical route the passenger takes from the terminal to the cabin (Fig.3). As both figures suggest, before entering the cabin, the passenger must:

- (a) have their wheelchair checked in and shift to an airport wheelchair;
- (b) have their personal belongings checked and undergo a physical security check;  
and

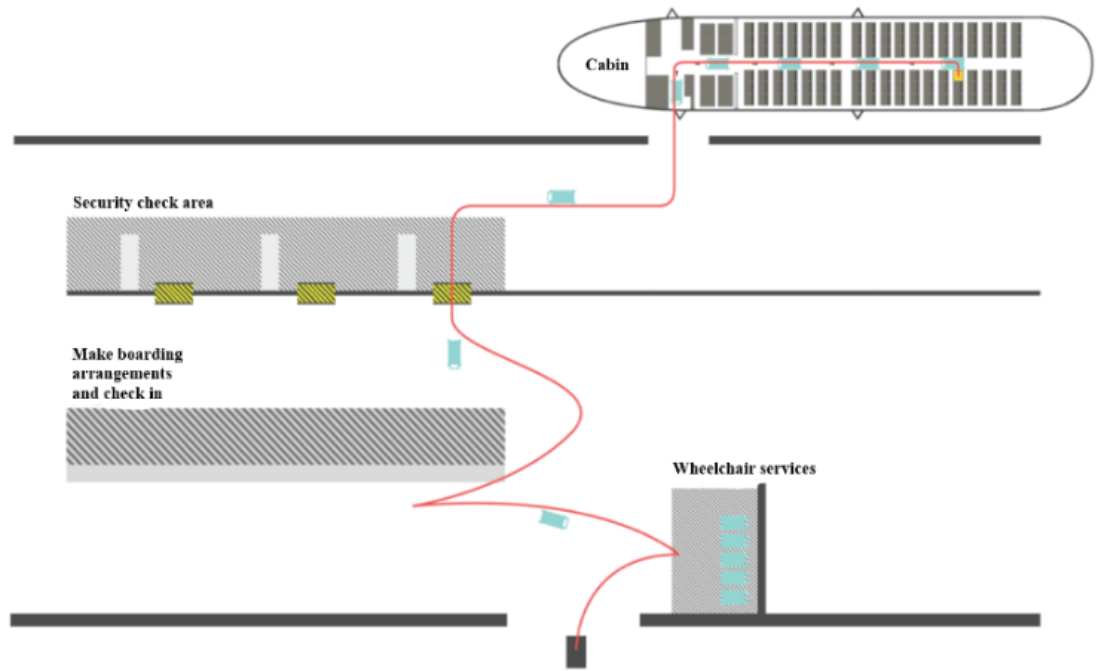

Figure 3: Tourist walking route map.

(c) shift to another wheelchair, which is designed exclusively for use in cabin aisles, and move to their seat.

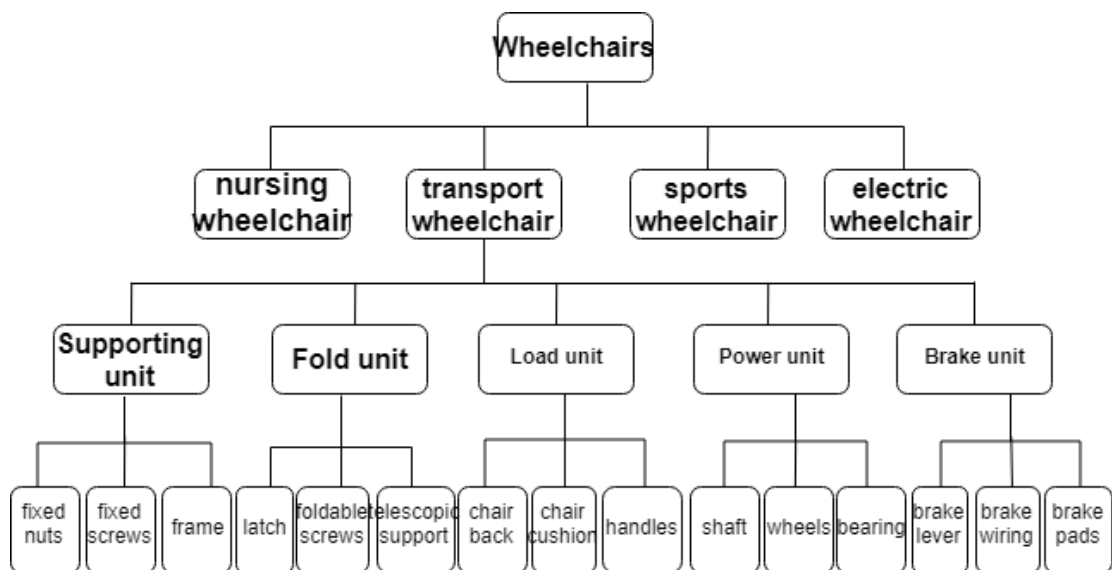

Figure 4: Wheelchair components.

To eliminate this inconvenience, this study proposed a foldable airport wheelchair that can be used in the terminal and the cabin.

### 3.2. Constructing an objective tree

In addition to categorizing wheelchairs into nursing, transport, active, and electric types, this study dissected the transport wheelchair into constituent units (Fig. 4):

- (a) support unit: comprises structural elements and connects other units.
- (b) folding unit: applies when the user moves from the terminal to the cabin.
- (c) load unit: sustains the user.
- (d) power unit: drives the wheelchair to move.
- (e) brake unit: acts as a brake on the wheelchair.

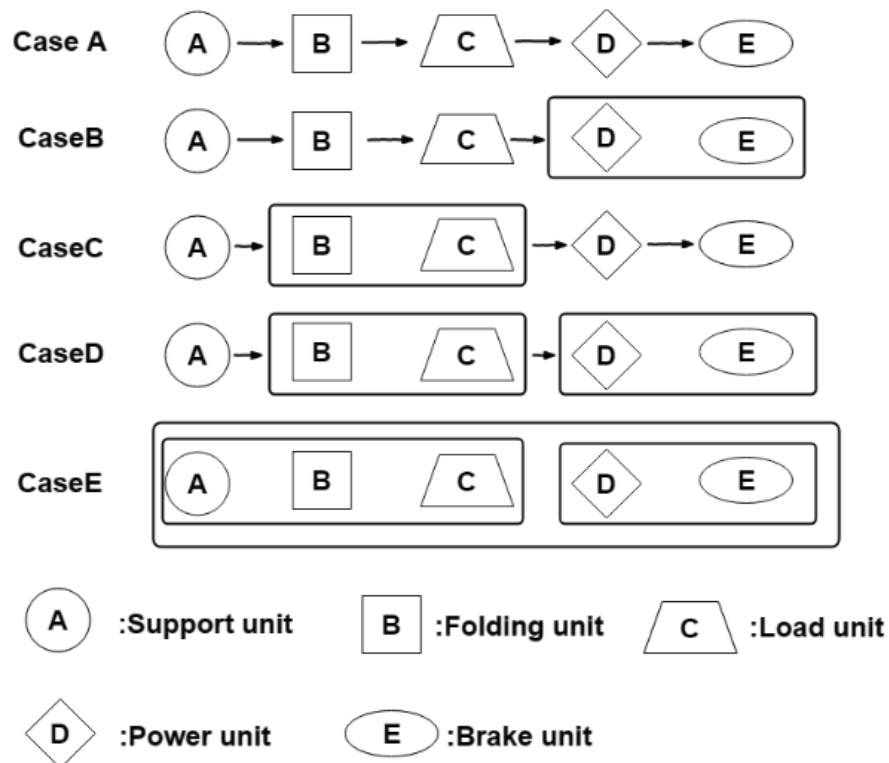

Figure 5: Different configurations of wheelchair constituent units.

### 3.3. Developing the wheelchair concepts

The development of a product’s model and components involves three variables: (a) the configuration of primary functions based on structural variables, (b) the spatial arrangement of all product components, and (c) the size of structural components and the spatial size of all components. This development procedure also involves determining whether (a) the spatial position for each component is the most appropriate, (b)

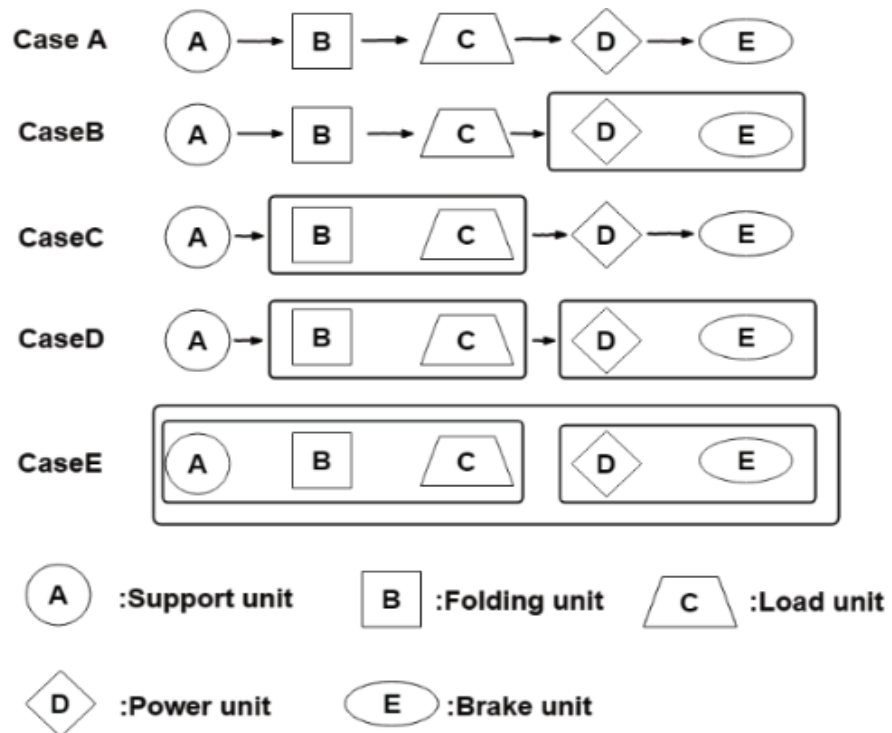

Figure 6: Spatial arrangements of wheelchair constituent units.

the overall configuration makes it the easiest to use the product, and (c) components after the configuration coordinate optimally.

TABLE 2: Quality criteria used during the Pugh concept selection on proposed wheelchair design concepts.





Whether the wheelchair configuration meets the needs of target customers	Whether the wheelchair is easy to maintain	Whether the form of the wheelchair is groundbreaking	Whether it is difficult to change the form of the wheelchair
Whether the wheelchair configuration meets special needs	Whether the wheelchair provides seating comfort	Whether the wheelchair has sufficient seating space	Whether it is safe for people with disabilities to use

### 3.4. Analyzing different configurations of wheelchair units (primary functions) based on structural variables

The FSM was used to yield five design cases; each presented a distinctive combinations of wheelchair constituent units (Fig. 5). Among them, the most modularized was Case E, which used Units A-C as a module to reduce material loss and simplified the wheelchair’s manufacturing process to make it easier to assemble. Units D (power) and E (brake) were closely related; therefore, integrating both units could make it cheaper to prepare the manufacturing mold and assemble the wheelchair.

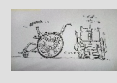

TABLE 3: Selection of wheelchair pugh selection forms.

Criterion\Design concept						Weight
Concept		A	B	C	D	
Whether the wheelchair configuration meets special needs	D	+	+	+	+	5
Whether the form of the wheelchair is groundbreaking	A	+	S	-	+	3
Whether the wheelchair configuration meets the needs of target customers	T	+	+	+	+	4
Whether the wheelchair has sufficient seating space	U	-	-	S	S	3
Whether the wheelchair is easy to maintain	M	S	S	S	-	2
Whether the wheelchair provides seating comfort		+	S	S	S	4
Whether it is difficult to change the form of the wheelchair		+	-	S	-	5
Whether it is safe for people with disabilities to use		-	S	+	S	4
Total score		3	0	2	2	
Weighted total score		14	1	10	5	

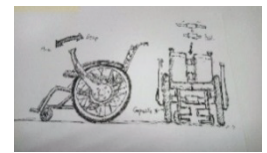
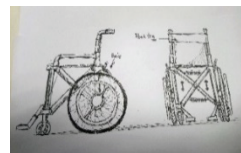
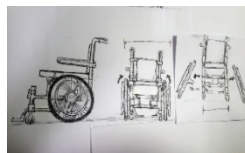
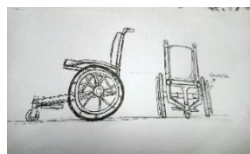

### 3.5. Analyzing different spatial arrangements of wheelchair constituent units

The FSM was used to produce four spatial arrangements of wheelchair constituent units (Fig. 6):

Cases A, B, C, and D. Case B was the most appropriate spatial arrangement. In this study, an easy-to-carry wheelchair was designed on the basis of the way existing wheelchairs are assembled.

**Figure 7:** Concept A.

**Figure 8:** Concept B.

**Figure 9:** Concept C.

**Figure 10:** Concept D.

### 3.6. Selecting design concepts

On the basis of the results of the aforementioned analyses, four wheelchair design concepts were constructed (Figs. 7-10). To identify suitable and practical wheelchair

**Figure 11:** Front Sight View.

**Figure 12:** Back Sight View.

**Figure 13:** Right Sight View.

**Figure 14:** View Model.

design concepts, the Pugh concept selection was performed to evaluate the concepts on the basis of several criteria for wheelchair quality, namely practicality, ease of use, manufacturing feasibility, and ease of maintenance see on Table 3. The final selection show on Table 4.

## 4. Results

According to the above result. We use the final selection to build the 3D model show on the Figs. 11-14. The contraction mechanism was hidden below the cushion. In normal, wheelchair can stretch the steel pipe to fit user. When entering the cabin, We can shrink the wheelchair to fit the width of the cabin width. This can reduce the discomfort of replacing wheelchairs for people with disabilities.

## 5. Conclusion

Industrial designers typically use the black-box approach and their personal viewpoints and experiences to design products, without formulating specifications. This makes products prone to defects, malfunctions, or poor ease of use, prompting designers to have to readdress these limitations. In the current study, the Objective tree analysis, FSM, and Pugh decision-matrix method were used to develop an airport wheelchair that meets target users' needs and has both functional and aesthetic attributes. This design procedure may not only improve wheelchair quality and reduce the costs of wheelchair production but also enhance the likelihood of its mass production. Therefore, the design procedure is effective.

## References

- [1] World Health Organisation, Overview of ICF Components, 2001 <http://dx.doi.org/10.1055/s-0033-1338283>.
- [2] Turco, D., N. Stumbo, and J. Garncarz, "Tourism Constraints for People with Disabilities", *Parks & Recreation* 33(9):78-84, 1998
- [3] Poria, Y., Reichel, A., & Brandt, Y., "The flight experiences of people with disabilities: an exploratory study", *Journal of Travel Research*, 49(2), pp. 216-227, 2009
- [4] Brent A. Lovelock, "Planes, trains and wheelchairs in the bush: Attitudes of people with mobility-disabilities to enhanced motorised access in remote natural settings", *Tourism Management*, 31(3), pp. 357-366, 2010
- [5] S. W. Hsiao, "Concurrent design method for developing a new product," *International journal of Industrial Ergonomics*, vol. 29, pp. 41-55, 2002.
- [6] S. W. Hsiao, "Integrated FSM STM and DFA Method to Faucet Design," *Journal of the Chinese Institute of Industrial Engineers*, vol. 13, No. 3, pp. 225-23, 1996.

- [7] S.Pugh, "Concept Selection - A Method That Works", Proceedings, International Conference on Engineering Design, March 9-13, 1981.
- [8] Nigel Cross, Engineering Design Methods: Strategies for Product Design, John Wiley & Sons, USA, 2000.
- [9] Jyh-Rong Chou, Applying a Creativity-based Design Process to New Product Development, National Cheng Kung University, doctoral thesis., 2004